

LA BASTILLE

METAL. EVOLVED.

Christina Range Hood
 54"W x 56"H x 27"D Hood
 46-3/8" Liner

3/4" Backplate for Installation

3/4" Backplate for Installation

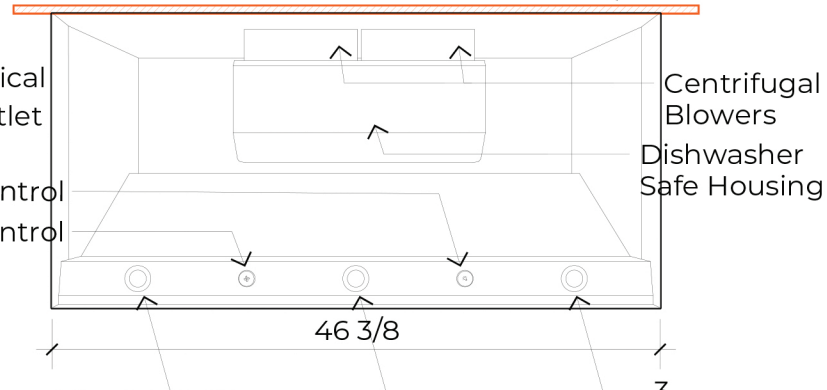
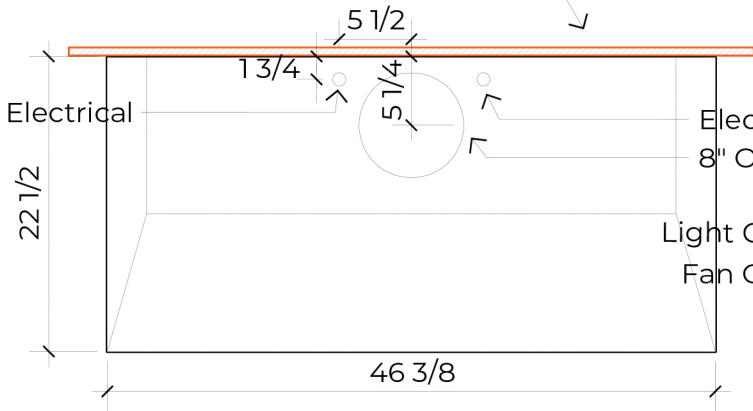

TOP VIEW

BOTTOM VIEW

3
Halogen
Lights

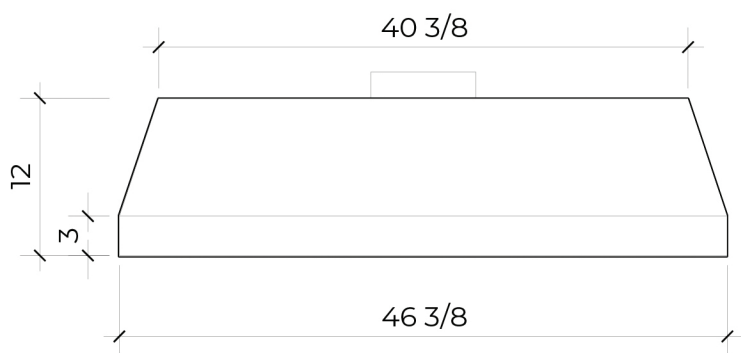

FRONT VIEW

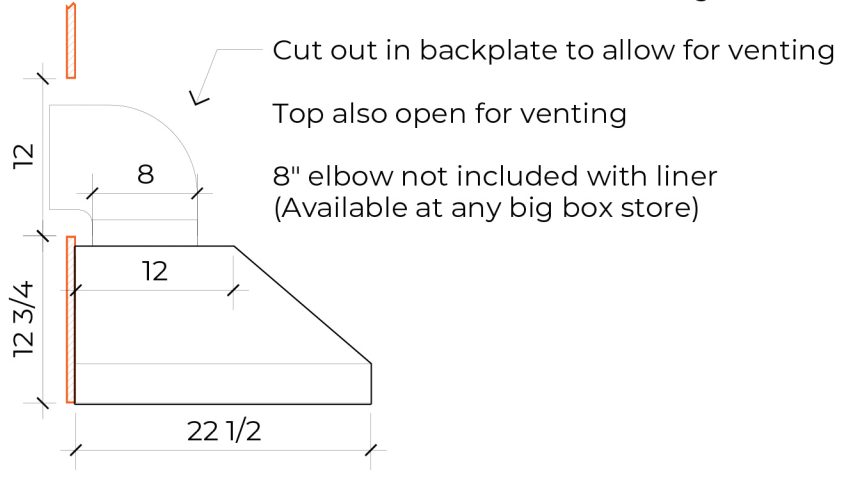

SIDE VIEW

Specifications:

1. 900 CFM Equivalent Liner; 6.5 Sones
2. Recommended bottom of liner to be mounted 27"-30" above range
3. Liner width should be equal to or 4" greater than width of cooktop
4. Duct can be vented through wall or through top
5. Bottom of hood will be closed around outside of liner
6. Buyer responsible for ducting & connections from top of liner to exterior
7. Typically requires standard #14 or greater 120V dedicated circuit suggested:
 Grounded Neutral (White), Hot (Black), & Ground (Green). Unit pulls 4 Amps Max.
 Be sure to follow local building codes.
8. Liner typically connected by licensed electrician

LA BASTILLE

METAL. EVOLVED

Christina Range Hood
54"W x 56"H x 27"D Hood
46-3/8" Liner

All Style Options Shown with Forsyth Edge
(May Not Represent Your Chosen Design)

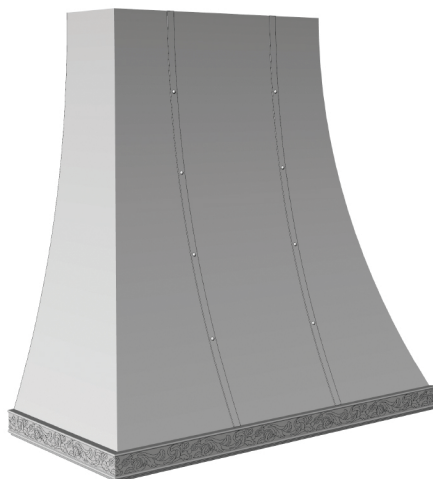
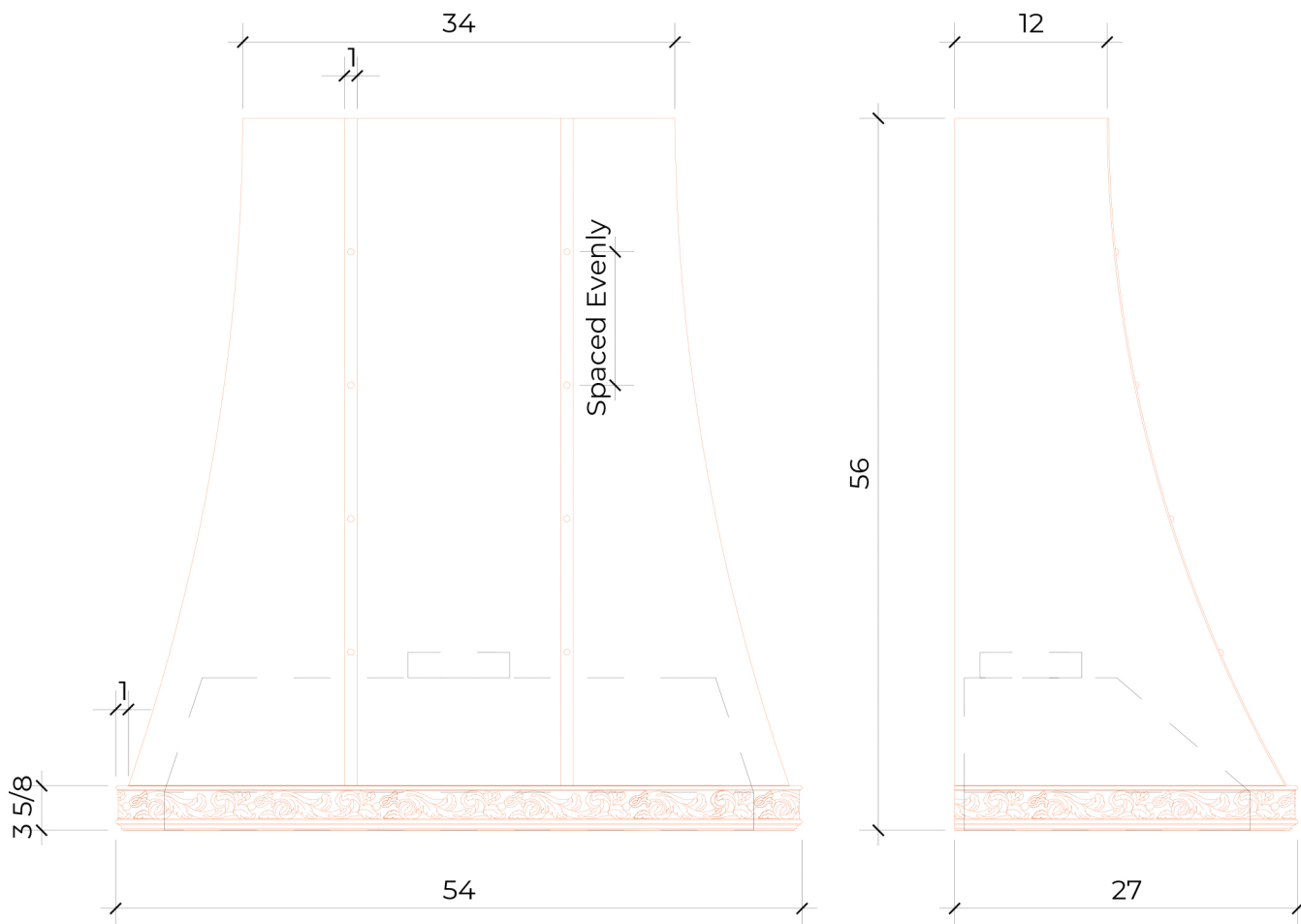

Rendering does not depict finish

LA BASTILLE

METAL. EVOLVED

Christina Range Hood
54"W x 56"H x 27"D Hood
46-3/8" Liner

All Style Options Shown with Whitaker Edge
(May Not Represent Your Chosen Design)

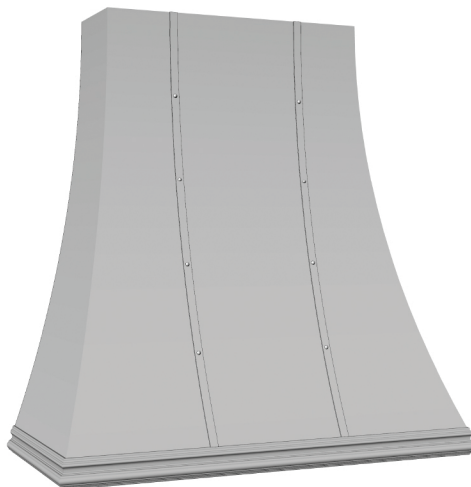
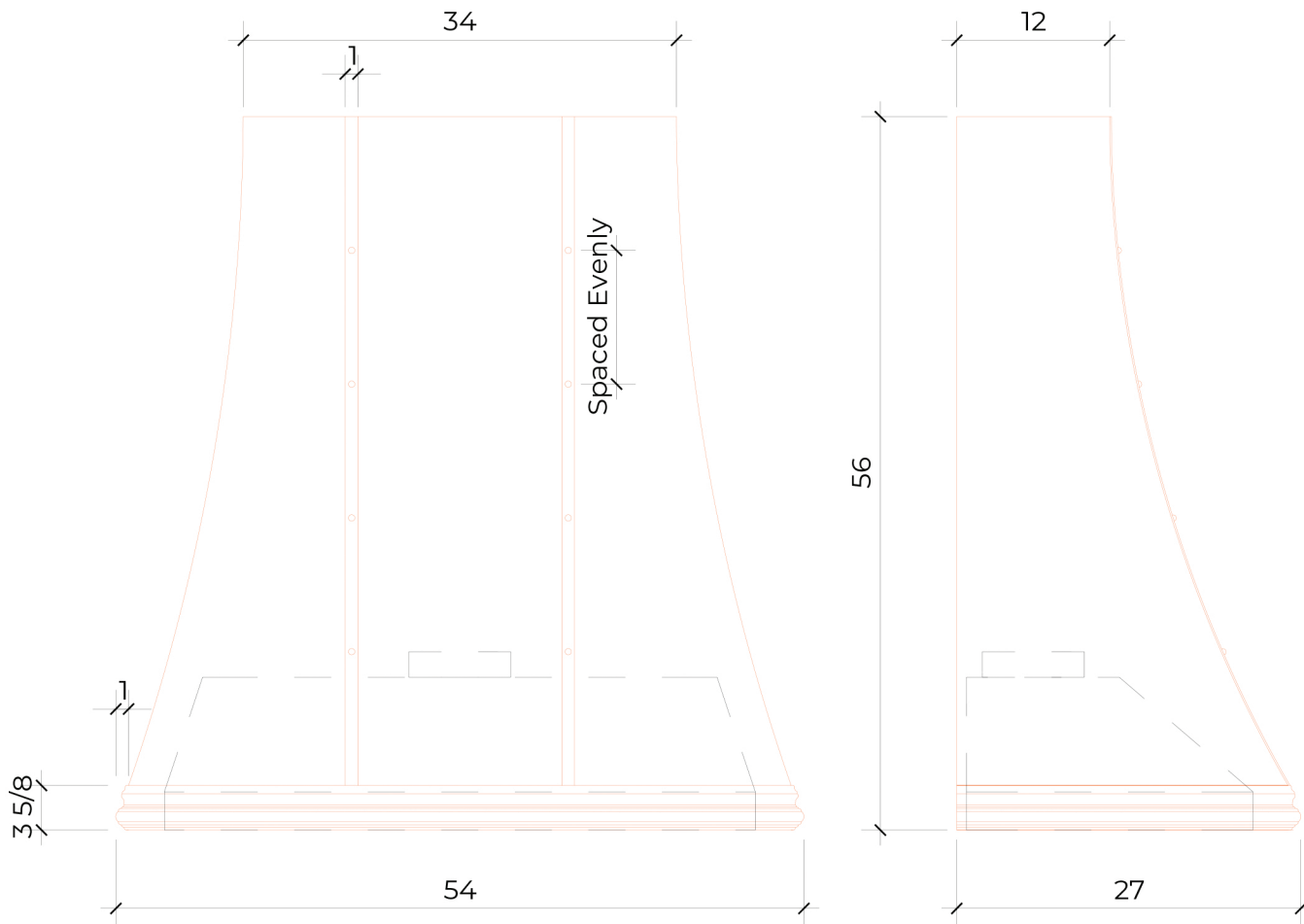

Rendering does not depict finish