

# LA BASTILLE

## METAL. EVOLVED.

Ann Range Hood  
42"W x 32"H x 27"D Hood  
34-3/8" Liner

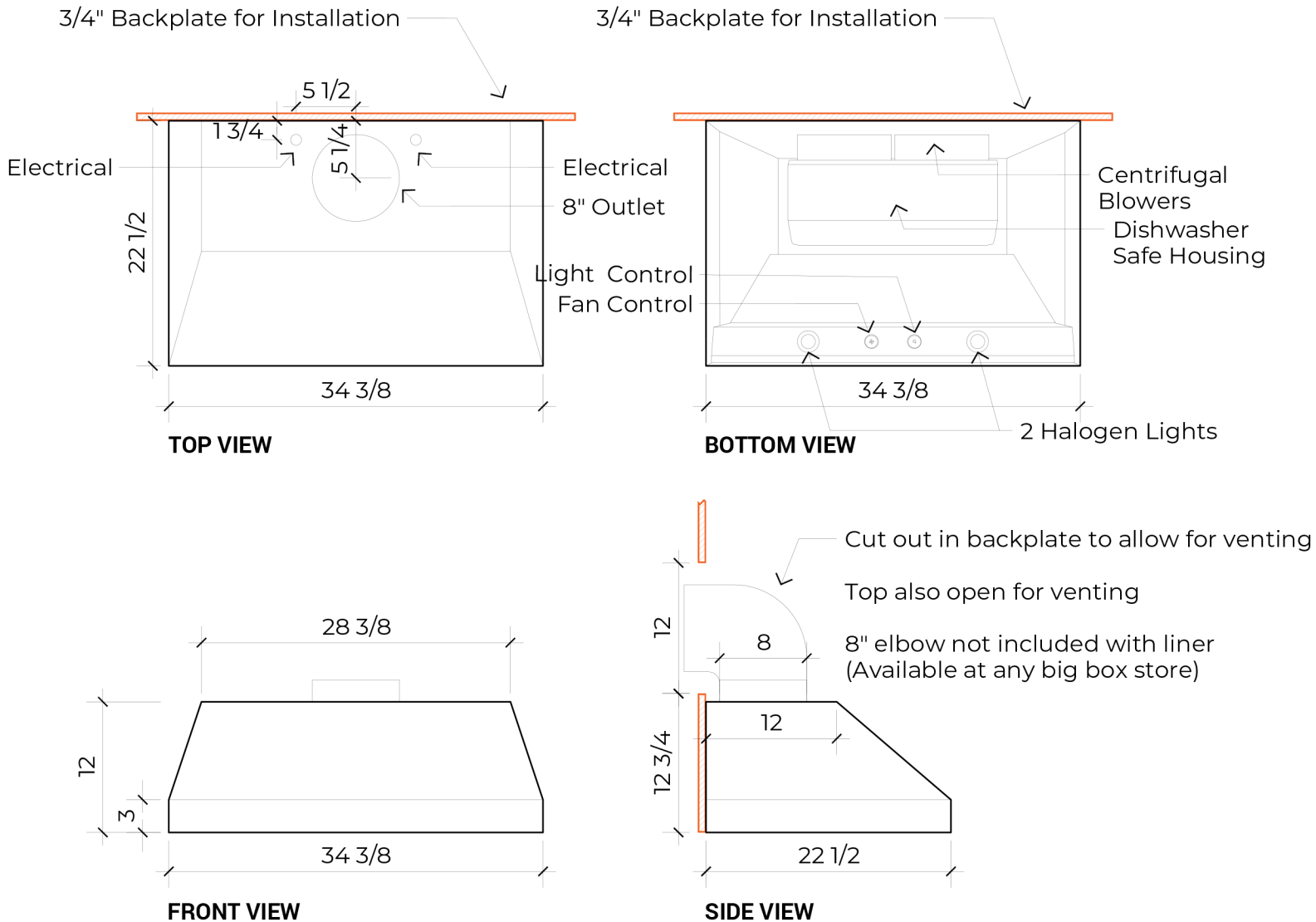

### Specifications:

1. 900 CFM Equivalent Liner; 6.5 Sones
2. Recommended bottom of liner to be mounted 27"-30" above range
3. Liner width should be equal to or 4" greater than width of cooktop
4. Duct can be vented through wall or through top
5. Bottom of hood will be closed around outside of liner
6. Buyer responsible for ducting & connections from top of liner to exterior
7. Typically requires standard #14 or greater 120V dedicated circuit suggested:  
Grounded Neutral (White), Hot (Black), & Ground (Green). Unit pulls 4 Amps Max.  
Be sure to follow local building codes.
8. Liner typically connected by licensed electrician

# LA BASTILLE

METAL. EVOLVED

Ann Range Hood  
42"W x 32"H x 27"D Hood  
34-3/8" Liner

All Style Options Shown  
(May Not Represent Your Chosen Design)

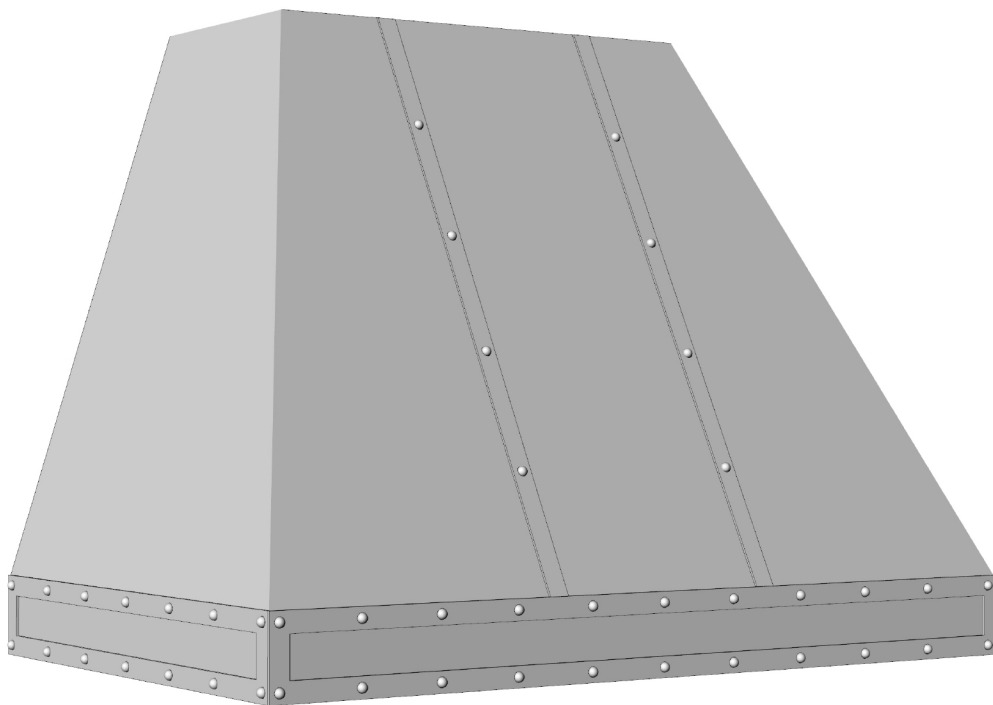
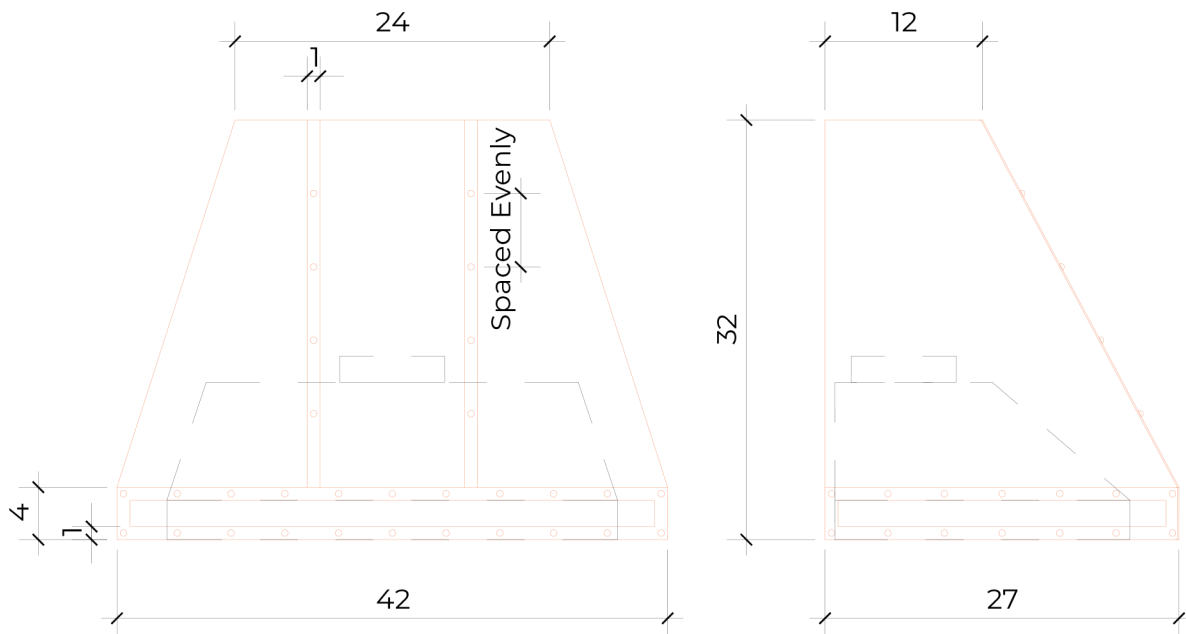

Rendering does not depict finish